



SnapLED 75
SnapLED 150

*Flexible LED solutions for
Automotive Signal Lighting*

Technical Datasheet DS12



AEC-Q101
Qualified

Meets SAE/ECE Automotive
Color Requirements

SnapLED 75 and SnapLED 150

Automotive LED Signal Lighting

Introduction

SnapLED 75 and SnapLED 150 are dual-mode binned making it easy to choose the right automotive signal product. Designers and consumers can count on SnapLED for color stability in rear combination lamps, front turn signals, and high mount stop lamp applications. The SnapLED package utilizes Philips Lumileds' pioneering Solderless Clinch technology, designed specifically to meet the automotive industry's need for extreme reliability. The Solderless Clinch technology uses a formable metal substrate which offers ease of manufacturing, styling flexibility, and thermal conductivity unmatched by other LED assemblies. The efficient optical design, high-brightness material, and high-current capability reduces the number of LEDs required for lighting functions and lowers the total cost and engineering complexity. SnapLED products meet SAE/ECE/JIS automotive color requirements and are AEC-Q101C qualified. SnapLED emitters are used for:

- Rear Combination Lamps
- Front Turn Signal Lamps
- High Mount Stop Lamps
- Mirror Turn
- Rear Fog Lamp

PHILIPS
LUMILEDS

Table of Contents

General Information.....	3
Product Nomenclature	3
Environmental Compliance.....	3
Selection Guide	4
Dual Product Binning	4
Reliability Testing	5
Electrostatic Discharge (ESD) Test.....	5
Maximum Ratings, $T_j=25^{\circ}\text{C}$	5
Optical & Electrical Characteristics.....	6
Mechanical Dimensions	7
Typical Spatial Radiation Pattern.....	8
Typical Relative Luminous Flux	9
Typical Junction Temperature vs. Intensity.....	10
Typical Forward Current Characteristics	11
Current Derating Curves.....	12
Thermal Resistance	13
Typical Wavelength Characteristics.....	14
Bin and Option Code Specifications.....	15
Low Current Luminous Flux Bin Definitions	16
Bin Range Option Codes	17
Color Bin Definition and Wavelength	17
Product Labeling Information.....	19

General Information

Product Nomenclature

The part number designation is explained as follows:

SSLABC-DEFG-xxxx

Where:

- SSL - designates the product type
- ABC - designates the current bin (150 mA or 75 mA)
- D - designates the package type (N = Narrow or W = Wide)
- E - designates the color (O = Red-orange, A = Amber)
- F - indicates the chip information and binning and packaging scheme
- G - indicates the binning and testing scheme.
- x - designates the minimum flux and flux bin range
- xxx - option codes for full standard part number.

Test Conditions for Optical Characteristics at Junction Temperature

Philips Lumileds tests SnapLED emitters for 20ms integration time at $T_j = 25^\circ\text{C}$. This datasheet specifies performance at a constant temperature of 25°C , except where noted.

Environmental Compliance

Philips Lumileds is committed to providing environmentally friendly products to the solid-state lighting market. SnapLED 75 and SnapLED 150 is compliant to the European Union directives on the restriction of hazardous substances in electronic equipment, namely the RoHS directive. Philips Lumileds will not intentionally add the following restricted materials to the SnapLED 75 and SnapLED 150 lead, mercury, cadmium, hexavalent chromium, polybrominated biphenyls (PBB) or polybrominated biphenyl ethers (PBDE).

Selection Guide

Product Selection Guide [1,2]

Table I.

LED Color SnapLed 75	Part Number	Drive Current Dual Mode	Viewing Angle $2\theta_{1/2}$ (Degrees) [1] Typ.
Red-Orange	SSL075-NO88	75 mA - 2.5 mA	45
	SSL075-WO88	75 mA - 2.5 mA	85
Amber	SSL075-NA88	75 mA - 2.5 mA	45
	SSL075-WA88	75 mA - 2.5 mA	85
SnapLed 150			
Red-Orange	SSL150-NO88	150 mA - 5 mA	45
	SSL150-WO88	150 mA - 5 mA	85
Amber	SSL150-NA88	150 mA - 5 mA	45
	SSL150-WA88	150 mA - 5 mA	85

Notes for Table I:

1. $2\theta_{1/2}$ is the off-axis angle at which the luminous intensity is half the axial luminous intensity.
2. Refer to page 21 for Flux bin selection and contact your respective technical service consultant for detail of Flux Φ_v (Lm) supportability.

Dual Product Binning

Automotive lamp makers can now take advantage of Philips Lumileds flux stability across a wide operating range with SnapLED 75 and SnapLED 150 dual binning. The dual binned products are designated with an “88” in the part number. SnapLED emitters are optimized and binned for use in dual-mode drive current applications such as automotive stop and tail lights, car and truck marker-turn, and tail-turn applications using low-cost, high-reliability resistor-diode drive circuits.

The optimized dual binned emitters offer 100% flux stabilization at temperature, allowing the user to operate the LEDs with flux & color stability over a dynamic range of forward voltages: SnapLED 75 from 75 mA–2.5 mA and SnapLED 150 from 150 mA–5 mA. This industry leading feature enables plug and play, immediate use of the SnapLED products without the need for additional handling, treatment or further characterization.

Key features include:

- Flexible dual binning scheme
- Higher maximum junction temperature of 135°C
- Higher flux at high & low currents
- Consistent color at high current
- Forward voltage bins with high current spacing of 60mV and with low current spacing of 30mV
- 20% flux bins at both high and low current with a guaranteed flux ratio between high and low current.

100% of the SnapLED 75 and SnapLED 150 products have 5 character binning eliminating the need to segregate parts between single and dual mode applications. Dual binning simplifies the production process, and ensures light output and color consistency over a wide operating range.

Reliability Testing

Philips Lumileds conducts extensive reliability stress testing before the introduction of new products to ensure that they meet the reliability expectations of the automotive market. The development of SnapLED includes reliability test simulations for both high voltage (24V) jump start and high voltage (18V) alternator failure conditions to ensure LED survivability, performance and quality integrity as well as design margin allowance.

Table 2.

Parameter	Pre-test Condition	SSL150 I_f (mA)	SSL75 I_f (mA)	T_a (°C)	Stress Duration (minute)
Current overstress	High Voltage (24V) Jump Start Simulation	300	150	55	5
	High Voltage (18V) Alternator Failure Simulation	200	100	55	120
Temperature overstress (Junction Temperature)		max 185°C			

Electrostatic Discharge (ESD) Test

Table 3.

Electrostatic Discharge (ESD) Test	Test Conditions	Rating
Human Body Model	8000V, 3 positive pulses, 3 negative pulses	JEDEC Class 3B (AEC: Class H3A)
Machine Model	400V, 3 positive pulses, 3 negative pulses	JEDEC Class B (AEC: Class 3M)
Charged Device Model	1000V, 3 positive pulses, 3 negative pulses	JEDEC Class III (AEC : Class C4)

Maximum Ratings, $T_j=25^\circ\text{C}$

Table 4.

Parameter	Symbol	SSL150 Rating	SSL075 Rating	Units
DC Forward Current ^[1,2]	I_F	150	75	mA
Pulsed Forward Current	I_{FP}	300	150	mA
Min DC Forward Current ^[2]	I_F	5	2.5	mA
Power Dissipation		446	223	mW
Ambient Temperature Range	T_a	-40 to +115		°C
Storage Temperature Range		-55 to +110		°C
High Temperature Chamber		125 (2 hrs)	125 (2 hrs)	°C
LED Junction Temperature	T_j	135	135	°C

Notes for Table 4:

1. Derating is linearly as shown in derating curves.
2. Min and Max currents recommended for continuous DC mode.

Optical & Electrical Characteristics

Optical Characteristics, $T_j=25^\circ\text{C}$ [5]

Table 5.

Part Number	Ratio of Luminous Intensity to total Flux	Dominant Wavelength (nm) [2]	Peak Wavelength	Total included Angle $\theta_{0.90V}$ (Degrees) [3]	Viewing Angle $2\theta_{1/2}$ (Degrees) [4]
	$I_v(\text{Cd}/\Phi_v(\text{lm}))$ [1]		λ_{peak} (nm) [2]		
	Typ.	λ_d Typ.	Typ.		Typ.
SSL075-NO88	2.0	617	626	70	45
SSL075-WO88	0.6	617	626	120	85
SSL075-NA88	2.0	590	592	70	45
SSL075-WA88	0.6	590	592	120	85
SSL150-NO88	2.0	617	628	70	45
SSL150-WO88	0.6	617	628	120	85
SSL150-NA88	2.0	592	593	70	45
SSL150-WA88	0.6	592	593	120	85

Notes for Table 5:

1. Intensity/Flux at HV axis
2. Dominant wavelength is derived from the CIE 1931 Chromaticity diagram and represents the perceived color. Philips Lumileds maintains a tolerance of ± 0.5 nm for dominant wavelength measurements.
3. $\theta_{0.90V}$ is the included angle at which 90% of the total luminous flux is captured.
4. $2\theta_{1/2}$ is the off-axis angle at which the luminous intensity is half the axial luminous intensity.

Electrical Characteristics, $T_j = 25^\circ\text{C}$

Table 6.

Parameter	Symbol	SSL150 Rating	SSL075 Rating	Units
Forward Voltage V_F (V)	V_F	2.8	2.8	V (Typ)
Reverse Voltage ($I_R = 100 \mu\text{A}$)	V_R	10	10	V
Capacitance $V_F=0, f=1\text{MHz}$	C	50	25	pF(Typ)
Thermal Resistance	$R\theta_{j-PIN}$	60	75	$^\circ\text{C}/\text{W}$
Speed of Response Time Constant, $e^{-t/\tau}$ s	τ_s	20	20	ns

Mechanical Dimensions

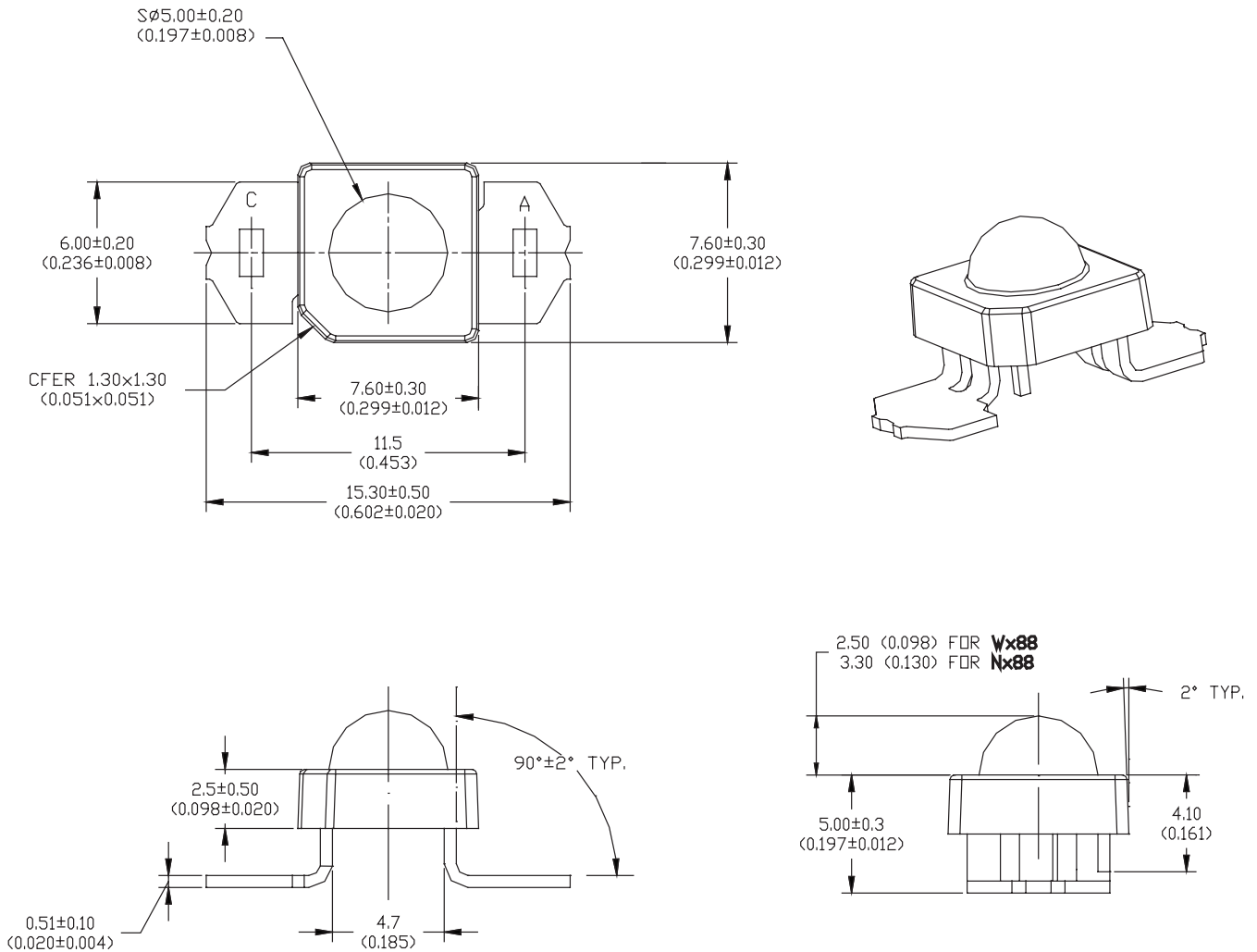

Figure 1. Package outline drawing.

Notes for Figure 1:

- Dimensions are in millimeters.
- Dimensions without tolerances are nominal.
- Cathode lead is indicated with a "C" and anode lead is indicated with an "A." (image is for illustration purposes)
- Clinch joint locations shown in dashed lines on top view of the emitter (11.50 mm spacing).

For more detailed information please visit www.philipslumileds.com or www.philipslumileds.cn.com.

Typical Spatial Radiation Pattern

SnapLED Wide ($\phi=0^\circ$)

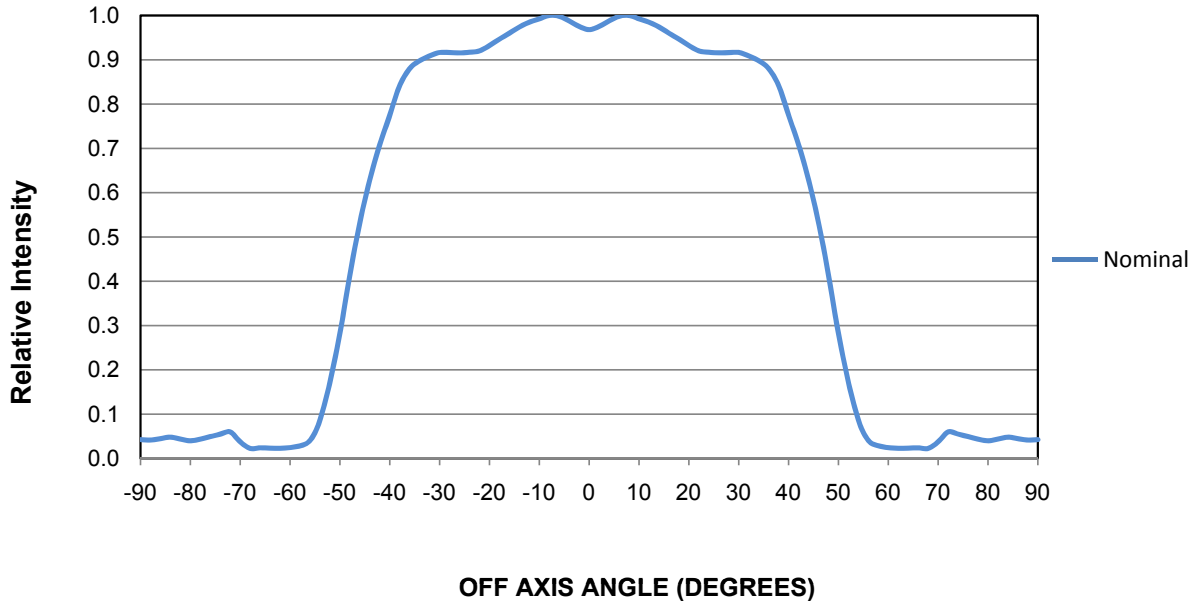

Figure 2. Relative luminous intensity vs. off axis angle (degrees).

SnapLED Narrow ($\phi=0^\circ$)

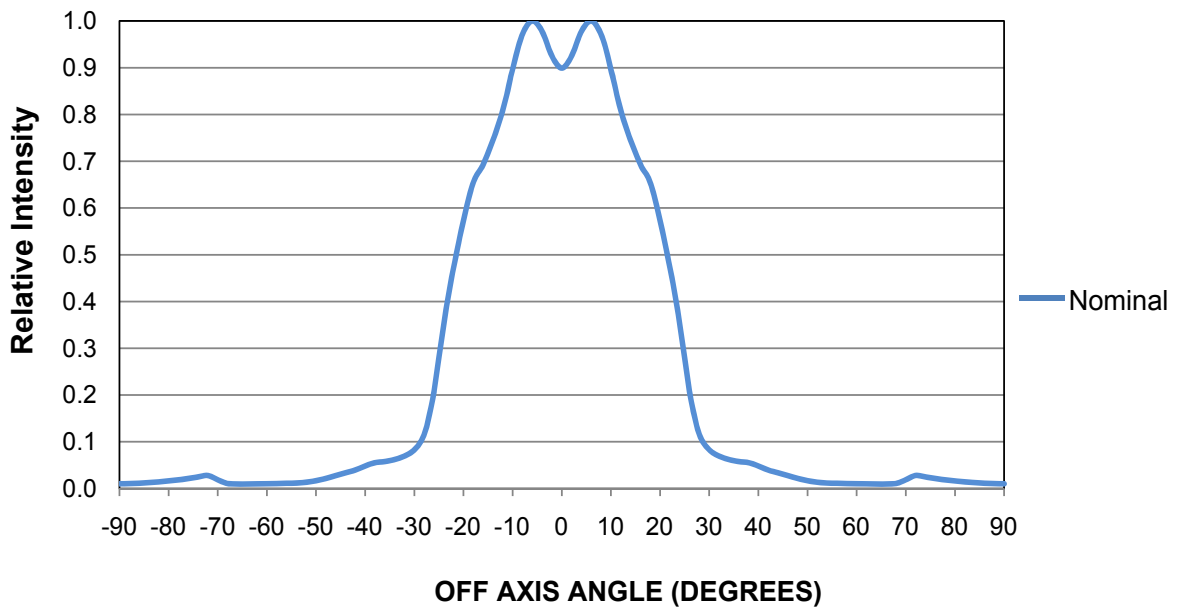

Figure 3. Relative luminous intensity vs. axis angle (degrees).

Typical Relative Luminous Flux

Typical Relative Luminous Flux vs. Forward Current for SnapLED 75

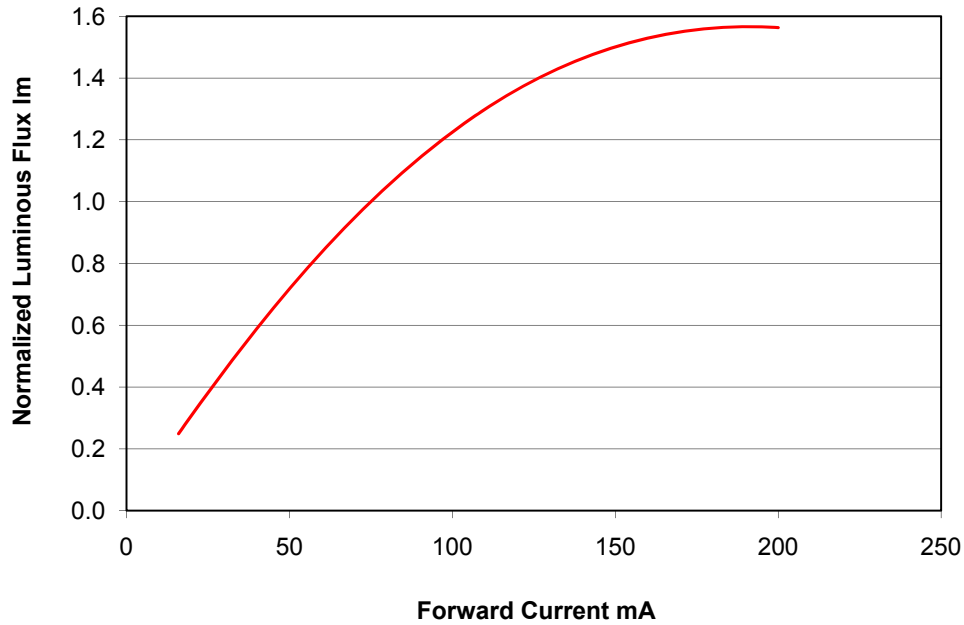

Figure 4. Typical relative luminous flux vs. forward current for SnapLED 75, red-orange & amber, junction temperature = 25°C.

Typical Relative Luminous Flux vs. Forward Current for SnapLED 150

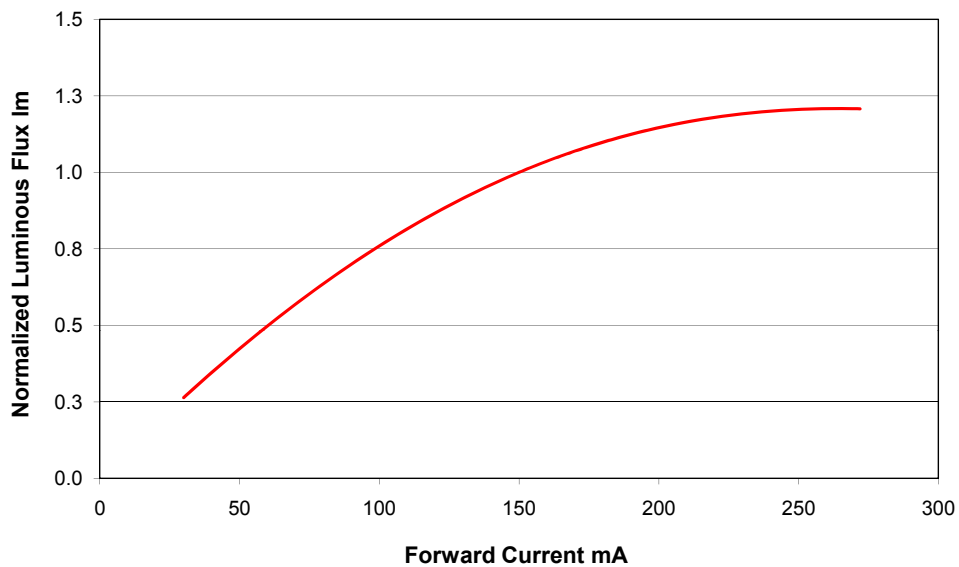

Figure 5. Typical relative flux vs. forward current for SnapLED 150, red-orange & amber, junction temperature = 25°C.

Typical Junction Temperature vs. Intensity

SnapLED 75 and SnapLED 150 Red-Orange and Amber Luminous Flux vs. Junction Temperature

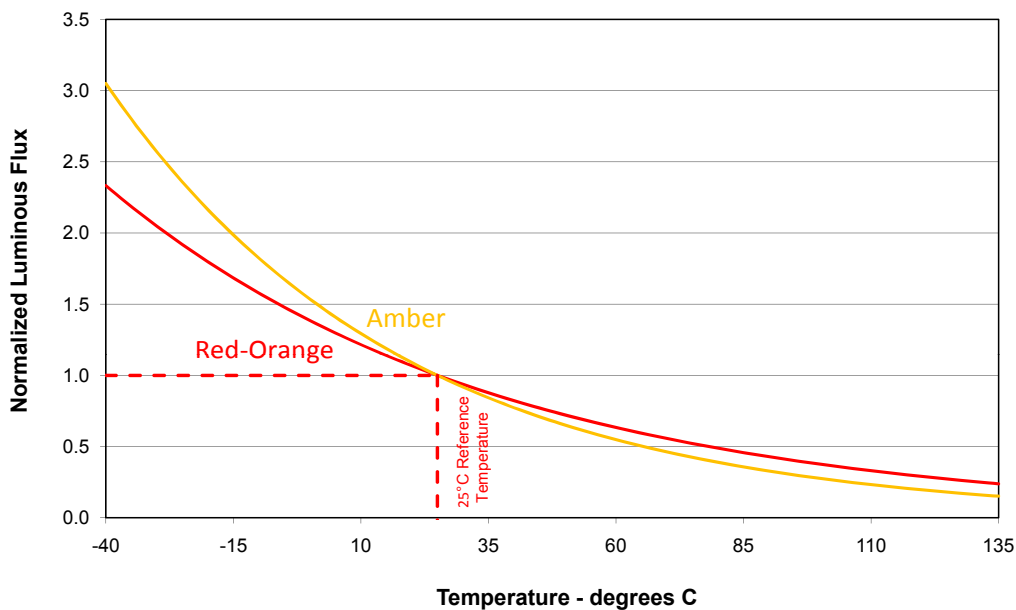

Figure 6. SnapLED luminous flux vs. junction temperature.

Typical Forward Current Characteristics

Typical Forward Current Characteristics, Junction Temperature = 25°C SnapLED 75

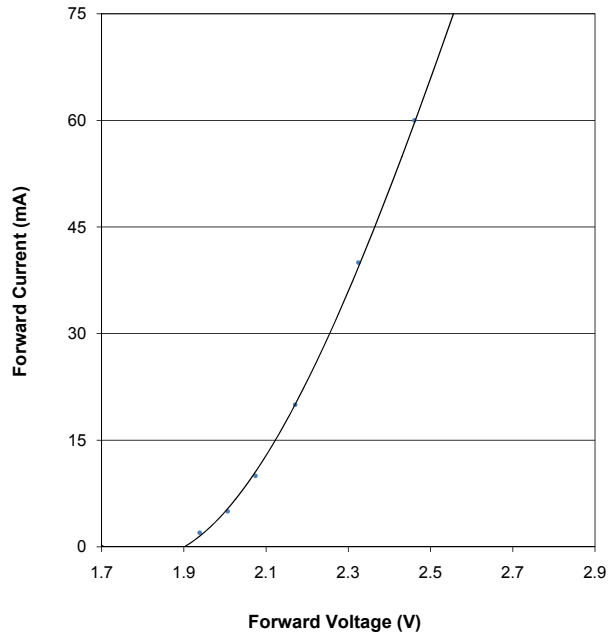

Figure 7. SnapLED 75 red-orange & amber forward current vs. forward voltage. Values are typical unless specified as maximum.

SnapLED 150

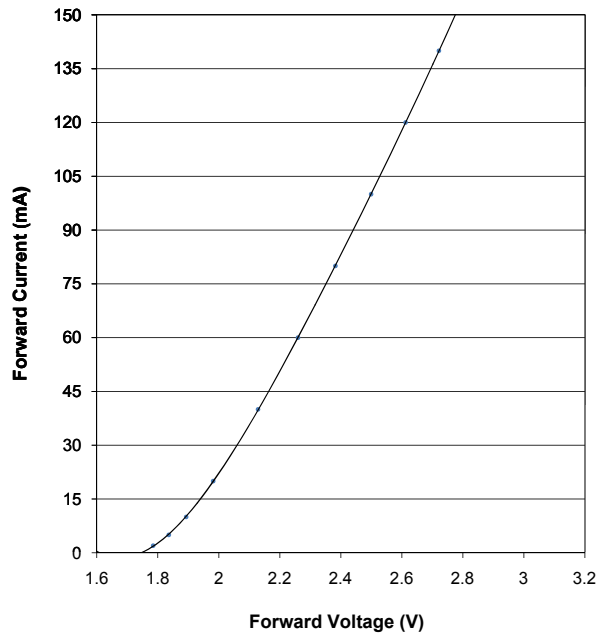

Figure 8. SnapLED 150 red-orange & amber forward current vs. forward voltage. Values are typical unless specified as maximum.

Current Derating Curves

SnapLED 75

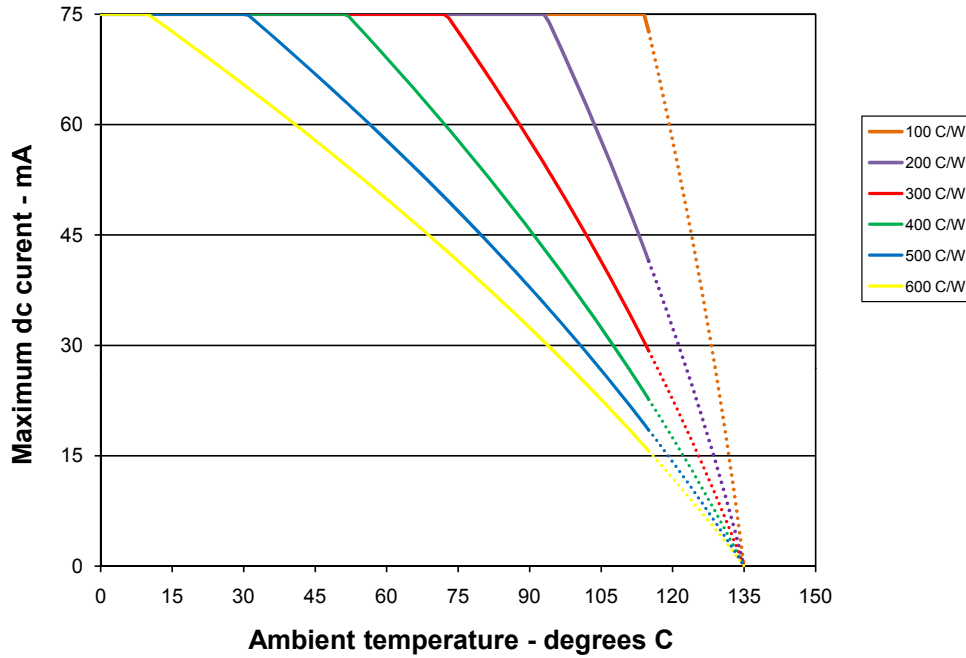

Figure 11. Current derating curve for SnapLED 75 mA drive current.

SnapLED 150

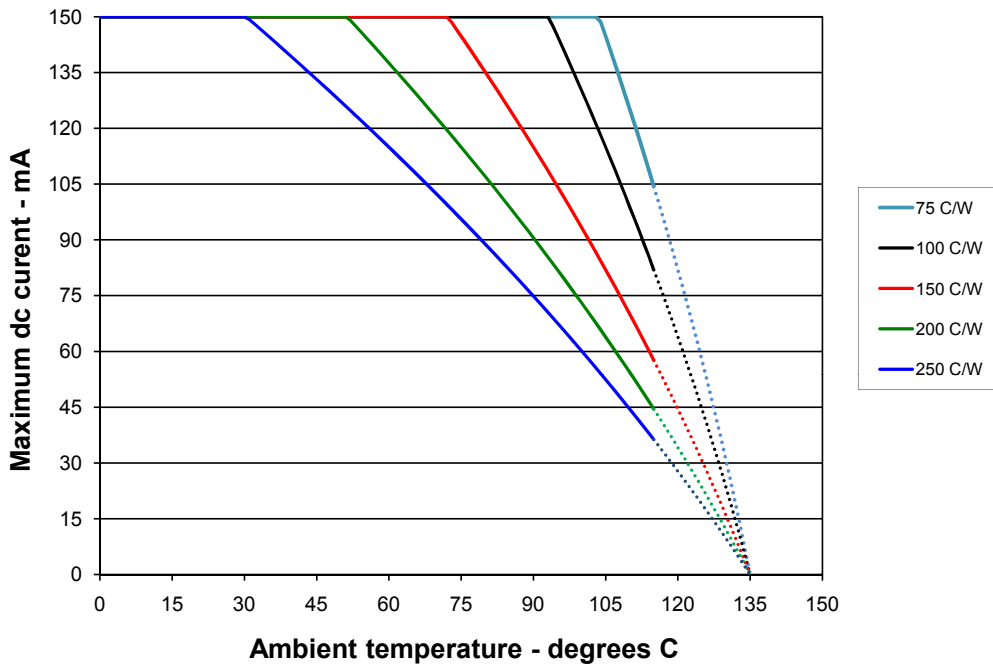

Figure 12. Current derating curve for SnapLED 150 mA drive current.

Thermal Resistance

Approximate Total Thermal Resistance vs. Clinch Frame Area Per Cathode SnapLED 75

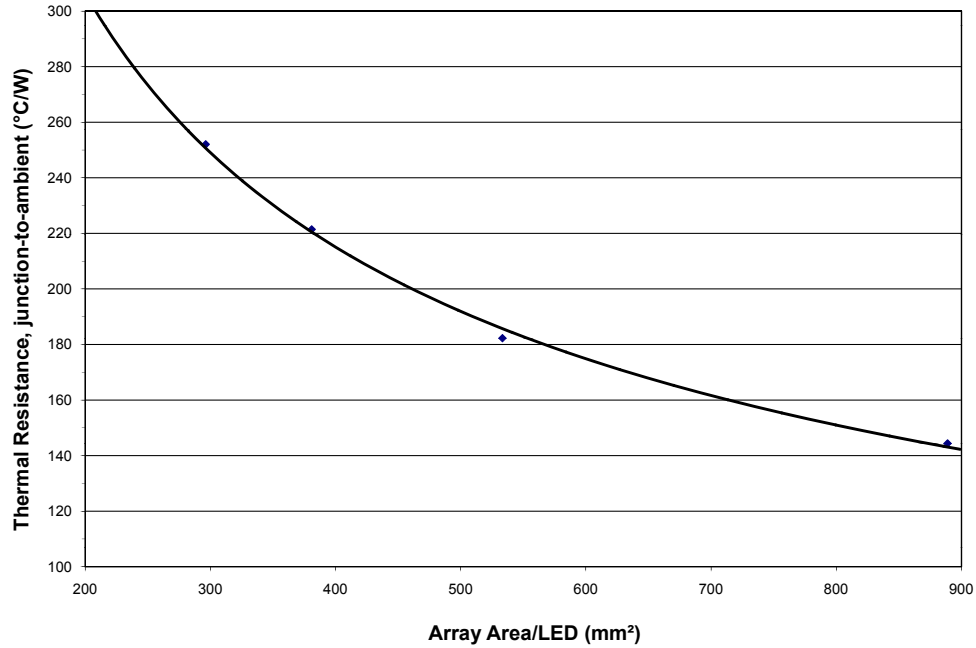

Figure 13. Approximate total thermal resistance vs. clinch frame area/LED - SnapLED 75.

SnapLED 150

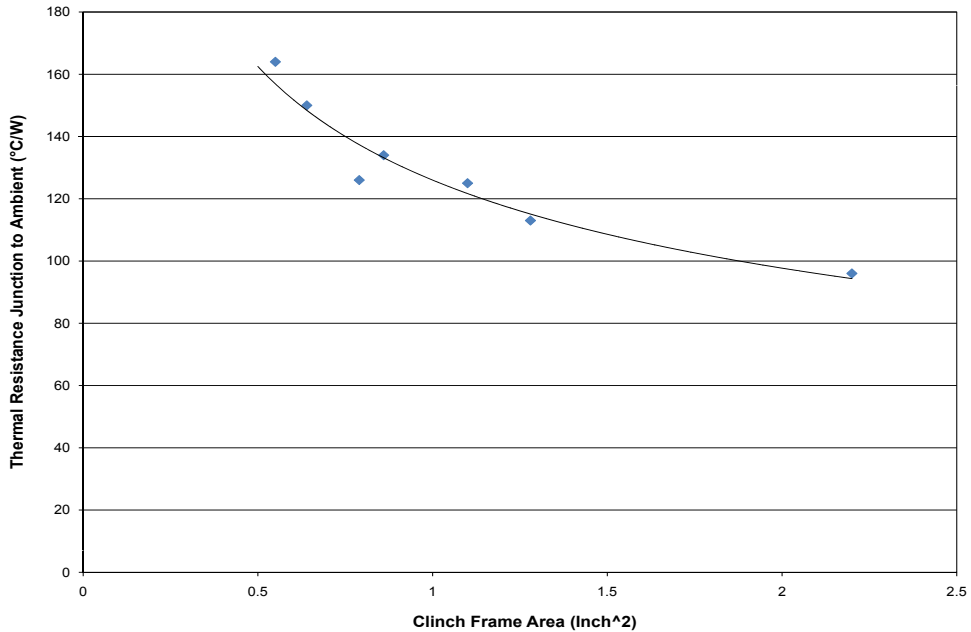

Figure 14. Approximate total thermal resistance vs. clinch frame area/LED - SnapLED 150.

Typical Wavelength Characteristics

Typical Wavelength Characteristics, Junction Temperature = 25°C

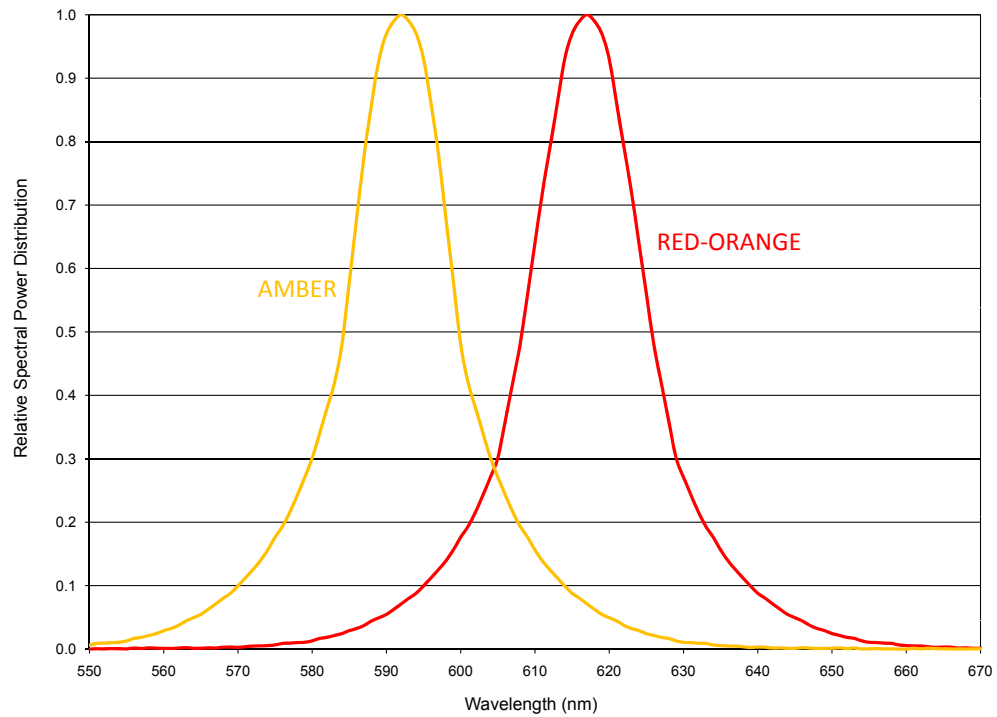

Figure 15. Relative intensity vs. wavelength.

Bin and Option Code Specifications

This section provides bin selection assistance for SnapLED LEDs. Product availability varies by color and other factors, and not all bin selection combinations are available. Contact your Philips Lumileds representative for further assistance.

Product availability varies by color and other factors, and not all bin selection combinations are available.

Table 7. Min Flux Bin @ High Current

High Flux Bin	Minimum Flux (lm)	Maximum Flux (lm)	Low Flux Bin
SnapLED 150 (SSL150-xO88)			
G	10.4	12.5	F, G, H
H	12.5	15.0	G, H, J
J	15.0	18.0	H, J, M
M	18.0	21.0	J, M, N
N	21.0	25.0	M, N, P
P	25.0	30.0	N, P, R
R	30.0	36.0	P, R, U
SnapLED 150 (SSL150-xA88)			
E	7.3	8.7	C, D, E, F, G
F	8.7	10.4	D, E, F, G, H
G	10.4	12.5	E, F, G, H, J
H	12.5	15.0	F, G, H, J, M
J	15.0	18.0	G, H, J, M, N
M	18.0	21.0	H, J, M, N, P
N	21.0	25.0	J, M, N, P, R
SnapLED 75 (SSL075-xO88)			
D	6.1	7.3	C, D, E
E	7.3	8.7	D, E, F
F	8.7	10.4	E, F, G
G	10.4	12.5	F, G, H
H	12.5	15.0	G, H, J
J	15.0	18.0	H, J, M
M	18.0	21.0	J, M, N
SnapLED 75 (SSL075-xA88)			
B	4.3	5.1	A, B, C, D
C	5.1	6.1	A, B, C, D, E
D	6.1	7.3	B, C, D, E, F
E	7.3	8.7	C, D, E, F, G
F	8.7	10.4	D, E, F, G, H
G	10.4	12.5	E, F, G, H, J
H	12.5	15.0	F, G, H, J, M

Note for Table 7:

- Refer to low current luminous flux bin table for low current bin information.

Low Current Luminous Flux Bin Definitions

Table 8. Low Current Luminous Flux Binning

Color	Applicable Product	Bin Code	Min Luminous Flux (lm)	Max Luminous Flux (lm)
Red-Orange	SSL150-xO88	F	0.29	0.35
		G	0.35	0.42
		H	0.42	0.50
		J	0.50	0.60
		M	0.60	0.72
		N	0.72	0.86
		P	0.86	1.02
		R	1.02	1.22
Amber	SSL150-xA88	U	1.22	1.46
		C	0.17	0.20
		D	0.20	0.24
		E	0.24	0.29
		F	0.29	0.35
		G	0.35	0.42
		H	0.42	0.50
		J	0.50	0.60
		M	0.60	0.72
		N	0.72	0.86
Red-Orange	SSL075-xO88	P	0.86	1.02
		R	1.02	1.22
		C	0.17	0.20
		D	0.20	0.24
		E	0.24	0.29
		F	0.29	0.35
		G	0.35	0.42
		H	0.42	0.50
Amber	SSL075-xA88	J	0.50	0.60
		M	0.60	0.72
		N	0.72	0.86
		A	0.12	0.14
		B	0.14	0.17
		C	0.17	0.20
		D	0.20	0.24
		E	0.24	0.29
		F	0.29	0.35
		G	0.35	0.42
H	0.42	0.50		
J	0.50	0.60		
M	0.60	0.72		

Bin Range Option Codes

Product availability varies by color and other factors and not all bin selection combinations are available.

Table 9.

High Current Flux Bin Codes

Bin Range Option Codes	Bin Range
0	All bin above the Minimum
2	2 flux bin
3	3 flux bin
4	4 flux bin
5	5 flux bin
6	6 flux bin

Notes:

- Option codes indicate the inclusive range of flux bins allowed above the indicated requested bin.

Color Bin Definition and Wavelength

Table 10.

Color	Color Code	Min (nm)	Max (nm)
Amber	1	588	590
	2	590	594
Red-Orange	3	613	618
	4	618	623
	5	623	628

Note for Table 10:

- Tester error for wavelength maintained at ± 1 nm.

Table 11. V_f Definition

High Current V_f Binning (150 mA / 75 mA)			
Color	V_f Label	Min V_f	Max V_f
Amber	1	2.37	2.43
Red-Orange	2	2.43	2.49
Red-Orange	3	2.49	2.55
Red-Orange	4	2.55	2.61
Red-Orange	5	2.61	2.67
Red-Orange	6	2.67	2.73
Red-Orange	7	2.73	2.79
Red-Orange	8	2.79	2.85
Red-Orange	9	2.85	2.91
Amber	A	2.91	2.97

Low Current V_f Binning (5 mA - 2.5 mA)			
Red-Orange and Amber	1	1.78	1.81
Red-Orange and Amber	2	1.81	1.84
Red-Orange and Amber	3	1.84	1.87
Red-Orange and Amber	4	1.87	1.90
Red-Orange and Amber	5	1.90	1.93
Red-Orange and Amber	6	1.93	1.96
Red-Orange and Amber	7	1.96	1.99
Amber	8	1.99	2.02

Table 12. V_f Definitions

Color	High Current V_f Binning (150 mA / 75 mA)	Low Current V_f Binning (5 mA - 2.5 mA)
	High V_f	Low V_f
Red-Orange	2	1
Red-Orange	3	1, 2
Red-Orange	4	1, 2, 3
Red-Orange	5	1, 2, 3, 4
Red-Orange	6	1, 2, 3, 4, 5
Red-Orange	7	1, 2, 3, 4, 5, 6
Red-Orange	8	2, 3, 4, 5, 6, 7
Red-Orange	9	3, 4, 5, 6, 7

Notes:

- V_f Pairing Definition applicable to red-orange only.
- All measurements done with 20ms integration time at $T_a = 25^\circ\text{C}$.
- Tester Error maintained at $3\sigma = \pm 10\%$. (Applies to lumin only).
- Tester Error maintained at $3\sigma = \pm 0.06\text{V}$ (Applies to forward voltage only).
- Tester Error maintained at $3\sigma = \pm 1\text{nm}$ (Applies to wavelength only).

Product Labeling Information

SnapLED Tubes

SnapLED LEDs are packaged in tubes for use with automatic insertion equipment. Each tube contains 60 LEDs. The LEDs in each tube come from a single category code, ensuring they are all well-matched for light output, color, and forward voltage. Each tube contains a rubber stopper at each end.

The tube label has both alphanumeric and bar code information. Figure 16 shows a sample label and a SnapLED LED tube. Labels include the Philips Lumileds logo, the LED device type in alphanumeric above the corresponding bar code, a large 5-digit category code.

Baby Label



Figure 16.



SnapLED Bundles

SnapLED emitter tubes are also available in shrink wrapped bundles. Each bundle includes 600 SnapLED emitters: ten SnapLED tubes. As with the individual tubes, bundles contain tubes from a single category code.

Product bundles include the following information: Philips Lumileds part number, 5 digit category code, lot code (for Philips Lumileds' internal use), quantity, and the date code range.

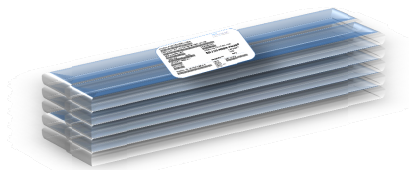

Figure 17. SnapLED bundle.

In addition, the following fields are provided for customer-specific information: vendor code, customer part number, customer revision level, and customer purchase order number. There are some restrictions regarding the format of each field, so please consult your Philips Lumileds representative for more information.

Bundle Label

Each bundle of tubes will have a bundle label as shown in Figure 20. The label indicates the part Number of SnapLED Products with CAT Code and the quantity of the products contained inside the box. Tubes will be packed into bundles of 10 tubes maximum and shipped in boxes measuring is (49.2 cm x 20.1 cm x 11.8 cm).

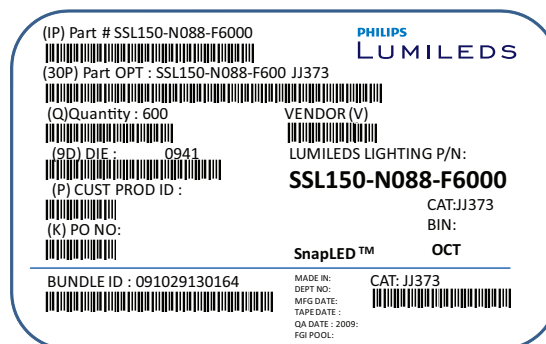

Figure 18.

Company Information

Philips Lumileds is a leading provider of LEDs for everyday lighting applications. The company's records for light output, efficacy and thermal management are direct results of the ongoing commitment to advancing solid-state lighting technology and enabling lighting solutions that are more environmentally friendly, help reduce CO₂ emissions and reduce the need for power plant expansion. Philips Lumileds LUXEON® LEDs are enabling never before possible applications in outdoor lighting, shop lighting, home lighting, consumer electronics, and automotive lighting.

Philips Lumileds is a fully integrated supplier, producing core LED material in all three base colors, (Red, Green, Blue) and white. Philips Lumileds has R&D centers in San Jose, California and in the Netherlands, and production capabilities in San Jose, Singapore and Penang, Malaysia. Founded in 1999, Philips Lumileds is the high flux LED technology leader and is dedicated to bridging the gap between solid-state technology and the lighting world. More information about the company's LUXEON LED products and solid-state lighting technologies can be found at www.philipslumileds.com.

©2012 Philips Lumileds Lighting Company. All rights reserved.
Product specifications are subject to change without notice.
LUXEON is a registered trademark of the Philips Lumileds
Lighting Company in the United States and other countries.

PHILIPS
LUMILEDS

www.philipslumileds.com
www.philipslumileds.cn.com